

# GP Batteries

## Data Sheet

Model No.: GP320BVH

Type	: Rechargeable Nickel Metal Hydride Button Cell	
Nominal Dimension	: $\Phi = 25.0\text{mm}$ H = 8.7mm	
Applications	: Recommended discharge current 3.2 to 160mA	
Nominal Voltage	: 1.2V	
Capacity	: Minimum : 320mAh Typical : 370mAh when discharge a 0.2C to 1.0V at 20°C	
Charging Condition	: 32mA for 16hrs at 20°C	
Service Life	: >500 cycles (IEC standard)	
Continuous Overcharge	: 32mA maximum current for 1 year No conspicuous deformation and/or leakage	
Weight	: 14.1g	
Internal Resistance	: Under 200m $\Omega$ upon fully charged	
Max. Charging Voltage	: 1.5V at 32mA charging	
Ambient Temperature Range	Standard Charging	: 0 to 45°C
	Discharging	: 0 to 45°C
	Storage	: -20 to 45°C

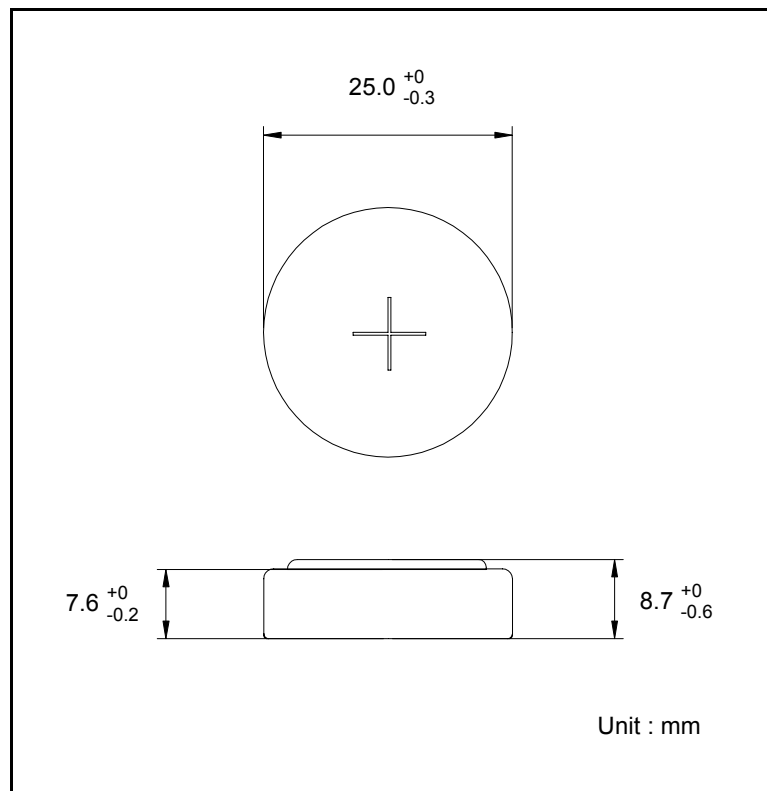

### Charge Characteristics

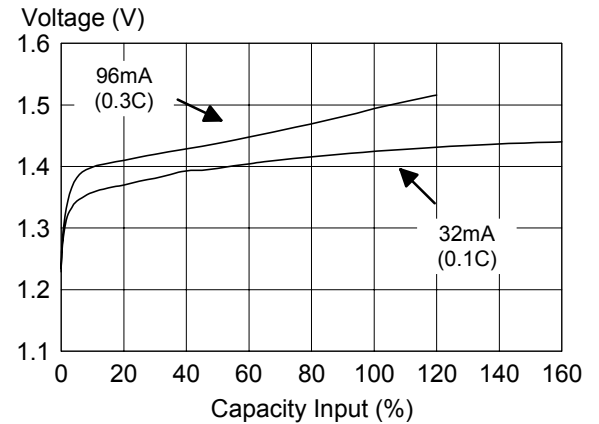

### Discharge Characteristics

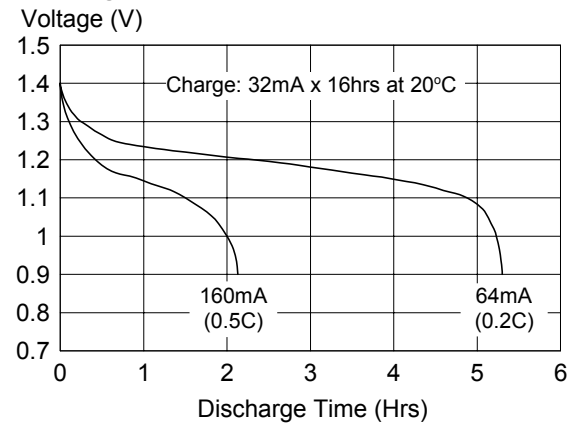

### Charge Retention Characteristics

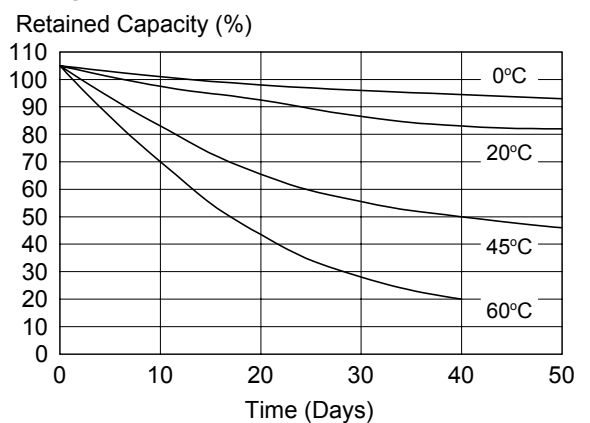

\* The information (subject to change without prior notice) contained in this document is for reference only and should not be used as a basis for product guarantee or warranty. For applications other than those described here, please consult your nearest GP Sales and Marketing Office or Distributors.